



# Timing Belts. Removal / Installation



by *Octane*

This thread by Lars "Octane" was posted on the Naked Goldwings Forum, 15 August 2006  
[Click here](#) to read the entire original thread. © Lars/Octane 2008, all rights reserved.

Before you undertake this procedure: [Read the Disclaimer.](#)

## **PLEASE NOTE:**

All references to Right mean 'right' as seen from sitting on the bike, NOT as you see it in the pictures. All references to Left mean 'left' as seen from sitting on the bike, NOT as you see it in the pictures.

The **T-1** mark means the **T** mark on the crank under which you'll find an **F** and the number **1**

This thread is for a 77 GL1000.

What you need:

- A set of timing belts. Part #14400-371-04/14400-371-14 for the early models (later models 78-79 have different number ...mmmm???) or alternatively Randakk suggests: Gates #T274, NAPA #250274, Goodyear Gatorback #40274 (available at AutoZone and others).
- A 12 mm ring spanner with a decent 'offset' (more on that later).



- And maybe a set of 'tension rollers'. Part # 14510-371-008 (they are about 60\$+ apiece (!!!)).

Oh yeah; you need to remove the radiator ... well not strictly, but I wouldn't want to do this job without removing it ... no way!

Remove front covers.

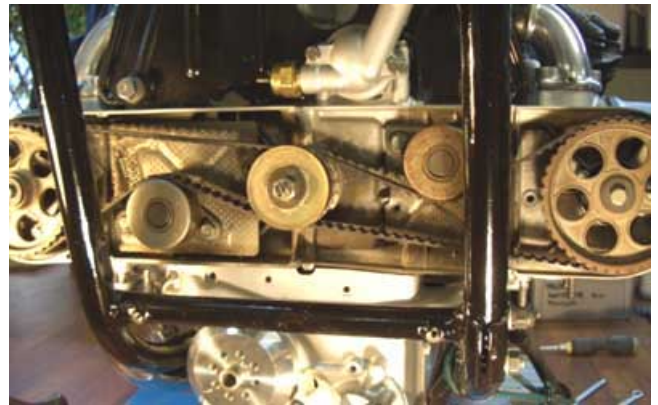

Remove spark plugs (you don't wanna turn the engine with the plugs in position.-).

Remove generator bolt cap so you can get in there with your offset 12mm ring spanner.



(This is where it needs to be offset).

This is the way the engine/crank will be turned during this procedure. **TURN CLOCKWISE ONLY!** You don't want to loosen that bolt.

Remove timing mark cap.

Turn engine as described above until the T-1 mark aligns with engine block marks (it looks a little 'out' on the photo, it's the angle).



**AND (this is important)** the pulley marks align with the marks on the engine cover like here on LEFT side (seen from sitting on bike ... remember).



and RIGHT side.

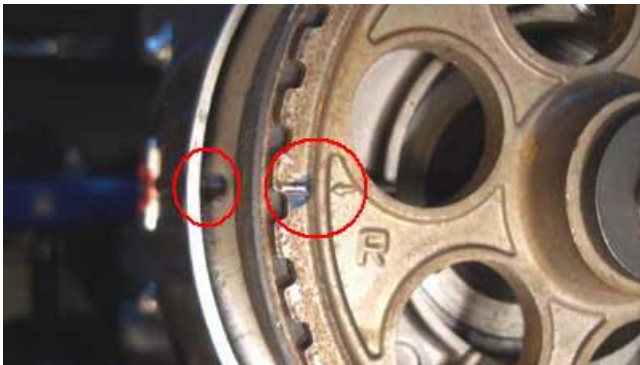

Mark this position on the central pulley and engine block.

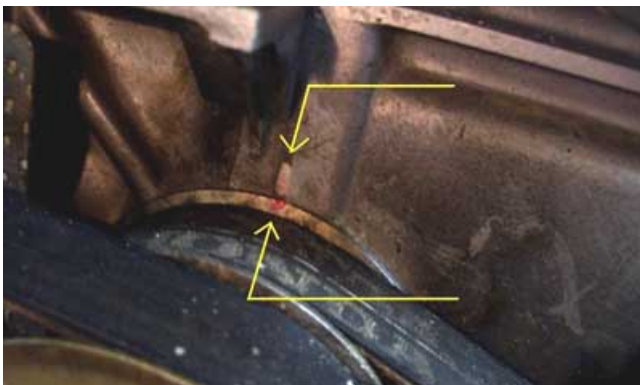

Now release the tensioner bolts. (\*)

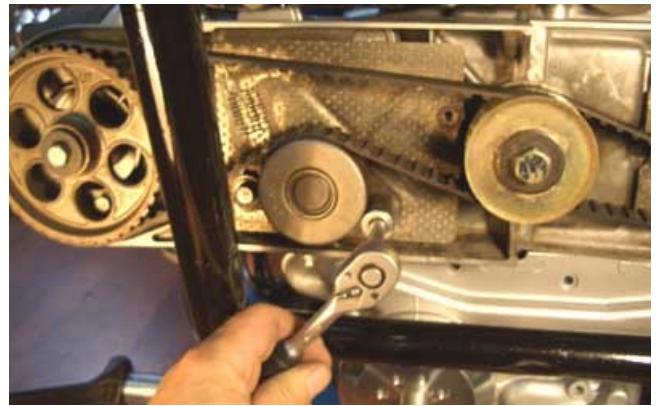

And remove the belt. (\*)

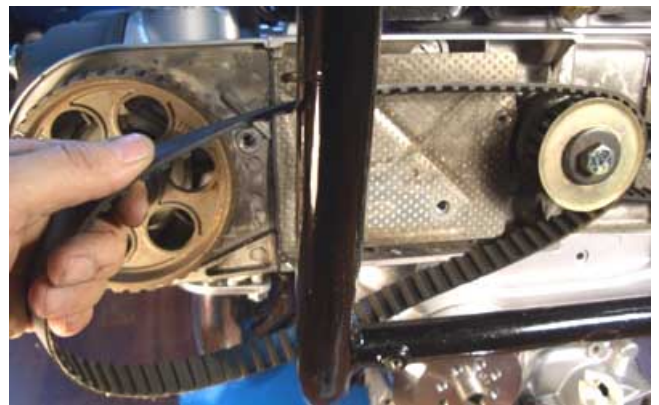

(\*) When you do that the right pulley (photo-left) will 'wander/turn' out of position when you remove the belt, as it is 'riding' on cam 'slope' (which is under the influence of the valve springs).

Don't worry. One thing you can do to calm your nerves and keep it in position: put the new belt loosely over the pulley and holding the pulley in the CORRECT POSITION (marks aligned) 'strip' a spanner to the frame.



Do not use the spanner to turn the pulley. Use your hands ... then 'lock' it with the spanner. (Make absolutely sure you do not turn (release/loosen) the bolt).

And, here's a nifty trick posted by **Mooseheadm5** in another thread: "...one thing that made it super easy (and



reduced the anxiety level quite a bit) was that I loosened the tappet adjusters all the way [...snip...] you do not have to fight the valve springs much, plus the cams do not want to snap back or forward so you do not necessarily need to use Octane's zip-tied wrench trick."

- Thanks, **Moosehead**.

Release left tensioner bolts.



Remove belt.

Put on new belt.

Check the tensioners or 'tension rollers'. You may think they are 'fine': they 'roll' and don't make funny sounds? You won't know until you've had a set of new rollers in your hands. They should be real 'tight' as a set of new roller bearings ... which I think they are, in fact. If they appear 'dry' or make any sounds; renew them and get rid of that high pitched whining sound associated with 'dry' rollers.

This is how they go on left side (remember...photo-right).



And the spring gets attached.



... Pulleys in correct position (crank pulley and cam pulley).

... Left belt tight at the bottom

... Tension roller loosely attached (let the spring do the tension). *(On photo it is not on yet ... ooops.)*

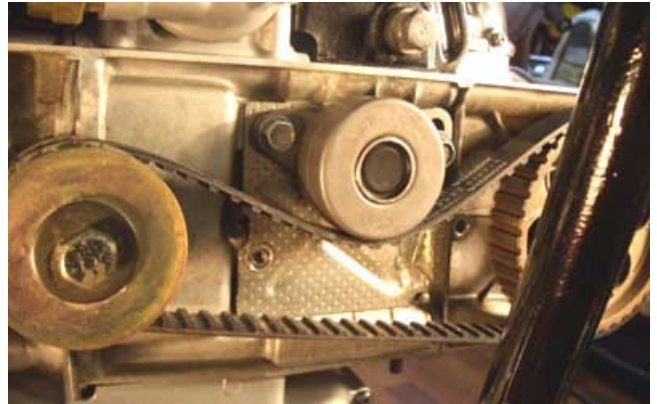

Check crank marks again.

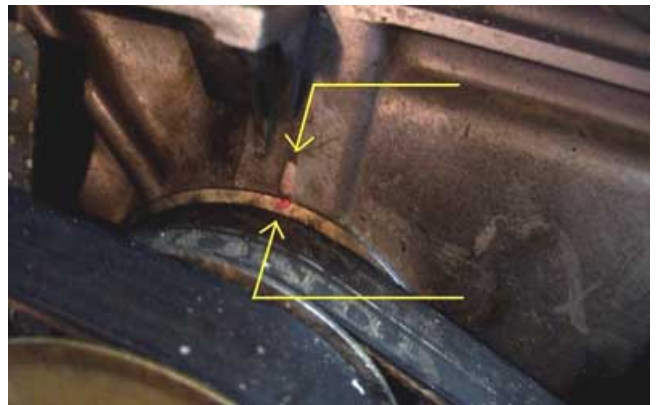

And check both cam pulley marks again.



Attach right tension roller (goes on like this).



And put on new belt

Check the crank marks again.

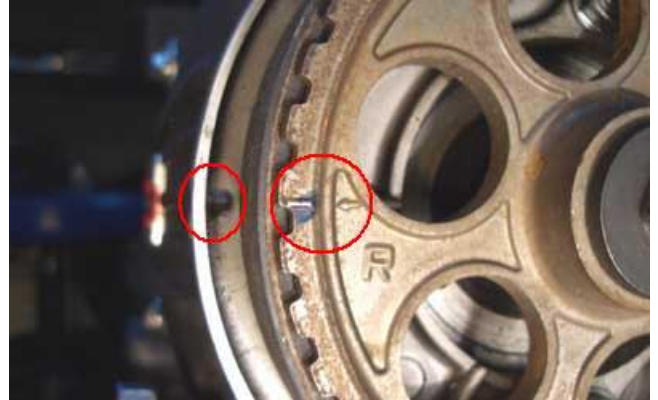

And re- re-check the crank marks.

Now the new belts are on and tensioner roller bolts are not yet tightened.

Now for 'adjusting' the belt tension.

LEFT side: (right in photos).

Check what mother Honda says:

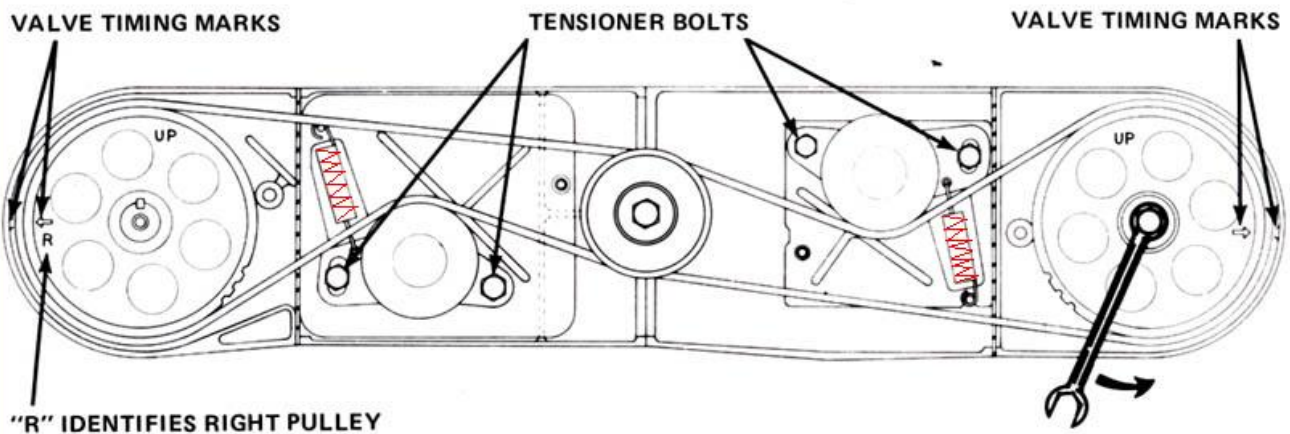

Apply pressure counter-clockwise on the camshaft pulley so the belt will be slack at the tensioner. With the tensioner bolts loosened, the spring pressure automatically positions the tensioner. Tighten the tensioner bolts.

NOTE: **the spring pressure automatically positions the tensioner** ...so no 'extra' pressure' on the tensioner before tightening the tensioner back plate bolts!!!

Easy! But how about the RIGHT side with that cam pulley being forced into a roll by the cam lobe. Mothership Honda is not telling!

There's been much talk in the forum about how to get the same tension on the right belt, and now I've finally found the perfect procedure/explanation in "Motorcycle Mechanics" magazine from February 1978 (!!!).

Am I that nerdy .... or what?! ho ha



*"To tension the right hand belt [...snip...] the engine should be turned through 360 degrees and the little arrows on the cam-wheels should then face inwards..."*

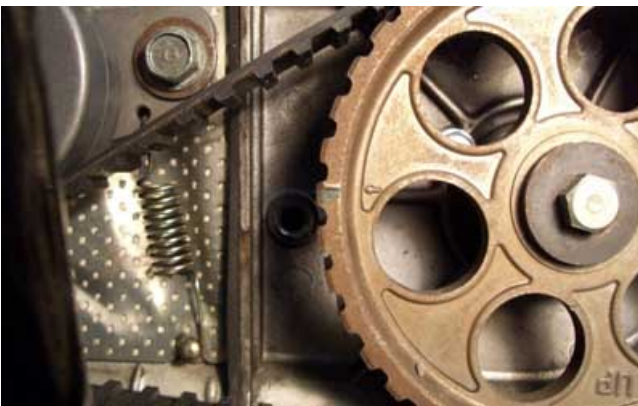
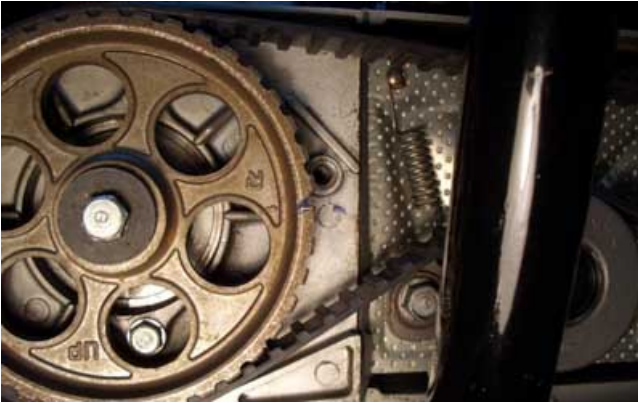

*... This is, by the way, with the engine once more positioned at "T1".(\*) You then do the same trick with the tensioner (and the spanner as per Honda) locking it up after the spring has done its job".*

Viola!

(\*) This might sound a bit confusing but remember: it takes 2 revolutions of the crank shaft for each revolution of the cam shaft.

Now: re-check everything ... all marks. **Turn the engine by hand a few times** ..and re-check.

This is an 'interference-engine', meaning that if the belt is few notches off; the valves will hit the top of the pistons!!!!

You have probably been doing this with the engine cold. The advice mentioned on Randakk's site is to check and re-adjust when the engine is warm, as it does expand horizontally warming up.

Here's what **briang** experienced:

"... I took off the belt covers to examine what I had done

before. The engine was very warm and the belts seemed very tight. Too tight in my estimation and I had not applied any more tension to the belts than the spring provided on the roller, just like Octane says. Returning here for confirmation of procedures, I came upon Randakk's tip being referenced somewhere. I then put a wrench on the bolts holding the tensioners, one side at a time, and watched carefully. Each time I loosened one tensioner (first the non-spring end enough to allow the plate to rotate and then the spring end), I visibly saw the cam belt relax, just a bit. The belt is still tight but it feels much better than the "singing" tight it seemed before ..."

- Thanks, **Brian!**

Do yourself (and future owners) a favor and mark down the time and km/miles for the belt replacement.

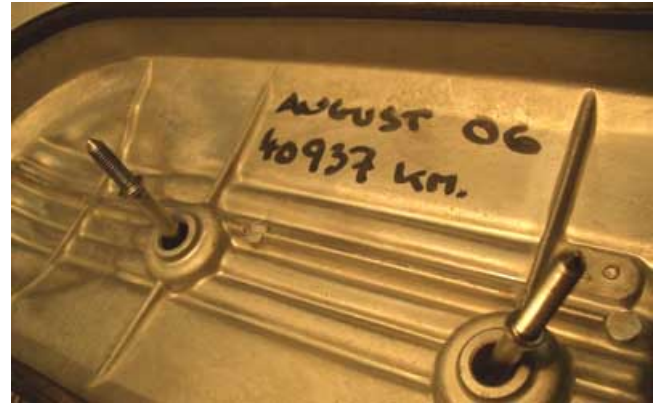

**Check/re-adjust valve clearance and check/re-adjust ignition timing.** New belts CAN move the ignition timing as much as a few degrees according to Randakk.

Live happily ever after!

*Octane, 15 August 2006*

*Last updated 24 June 2008*

---

## **Disclaimer**

Members of [Naked GoldWings.com](http://NakedGoldWings.com) (NGW) strive to help fellow members and guests. We give advice as friends, and share technical tips with each other. Any mechanical tasks that you take upon yourself as a result of instructions in the forums or this document is done so at your own risk. You alone will be responsible for ANY undertakings and/or consequences you may suffer as a result of misguidance. IF YOU AIN'T SURE, DON'T DO IT. When you decide to tackle a project ensure that you have the know-how to carry out these repairs and modifications. NGW members and administrators will not be held responsible for any errors or results encountered.

---